

---

# DUCTED AIR CONDITIONERS

---

**Come home to comfort with LG**



# Come Home To Comfort with LG air conditioners

—

LG makes life good by connecting with the real needs and desires of our customers and innovating around them. We passionately believe in improving the day-to-day lives of Australians via forward-thinking technological advancement.

## Why LG Ducted Air Conditioning

Designed for the way you live, our ducted air conditioners can be installed in a new home or tailored to an existing one. Our ducted units can typically be installed discreetly in residential houses - so you can create a space that's cool, comfortable and stylish.

To give you peace of mind, we also provide a **5 year** parts and labour warranty on our ducted systems, so comfort will be with you for years to come.

With LG Ducted System air conditioning products, you'll also enjoy benefits such as:

- **Optional Wi-Fi Control** - so that you can control your unit with your Smartphone, even when you're not at home\*.
- **Improved Energy Efficiency** - The latest Inverter technology from LG helps to lower cooling costs in the summer
- **Zone Control** - take control of up to 8 zones with the LG premium controller and indicate each zone name such as Office, Hallway, etc

For ease of installation, energy efficiency and flexibility to design your home stylishly, LG ducted air conditioning systems are the smart choice.

\*Wi-Fi Dongle Module required. Sold separately.

Feature can be accessed using LG SmartThinQ App on Android (v 4.1 or later) iOS (v iOS9 or later) smartphone. Internet connection required.





# MODEL LINE-UP













## SLIM DUCTED

R32

	Indoor Unit	Outdoor Unit	Cooling Capacity (kW) Min ~ Rated ~ Max	Heating Capacity (kW) Min ~ Rated ~ Max
UBN24R			2.8 ~ 6.8 ~ 7.8	3.2 ~ 7.5 ~ 8.3
UBN36R			4.5 ~ 9.5 ~ 13.0	5.0 ~ 10.8 ~ 13.7

# HIGH STATIC DUCTED

# R410A

	Indoor Unit	Outdoor Unit	Cooling Capacity (kW) Min - Rated - Max	Heating Capacity (kW) Min - Rated - Max
B30AWY7G6	 B30AWYN7G6	 B30AWYU4G6	2.5 - 8.8 - 9.6	2.7 - 9.4 - 11.1
B36AWY7G6	 B36AWYN7G6	 B36AWYU3G6	3.2 - 10.5 - 13.0	3.4 - 13.0 - 13.7
B42AWY7G6	 B42AWYN7G6	 B42AWYU3G6	4.0 - 12.5 - 14.8	4.0 - 15 - 16.5
B55AWY7G6	 B55AWYN7G6	 B55AWYU3G6	4.8 - 15.0 - 15.8	4.8 - 17.0 - 18.0
B62AWY9L6	 B62AWYN9L6	 B62AWYU7L6	7.2 - 18.0 - 19.8	8.2 - 20.6 - 22.7
B70AWY9L6	 B70AWYN9L6	 B70AWYU7L6	8.0 - 20.0 - 22.0	9.0 - 22.6 - 24.9

# SLIM DUCTED

R32

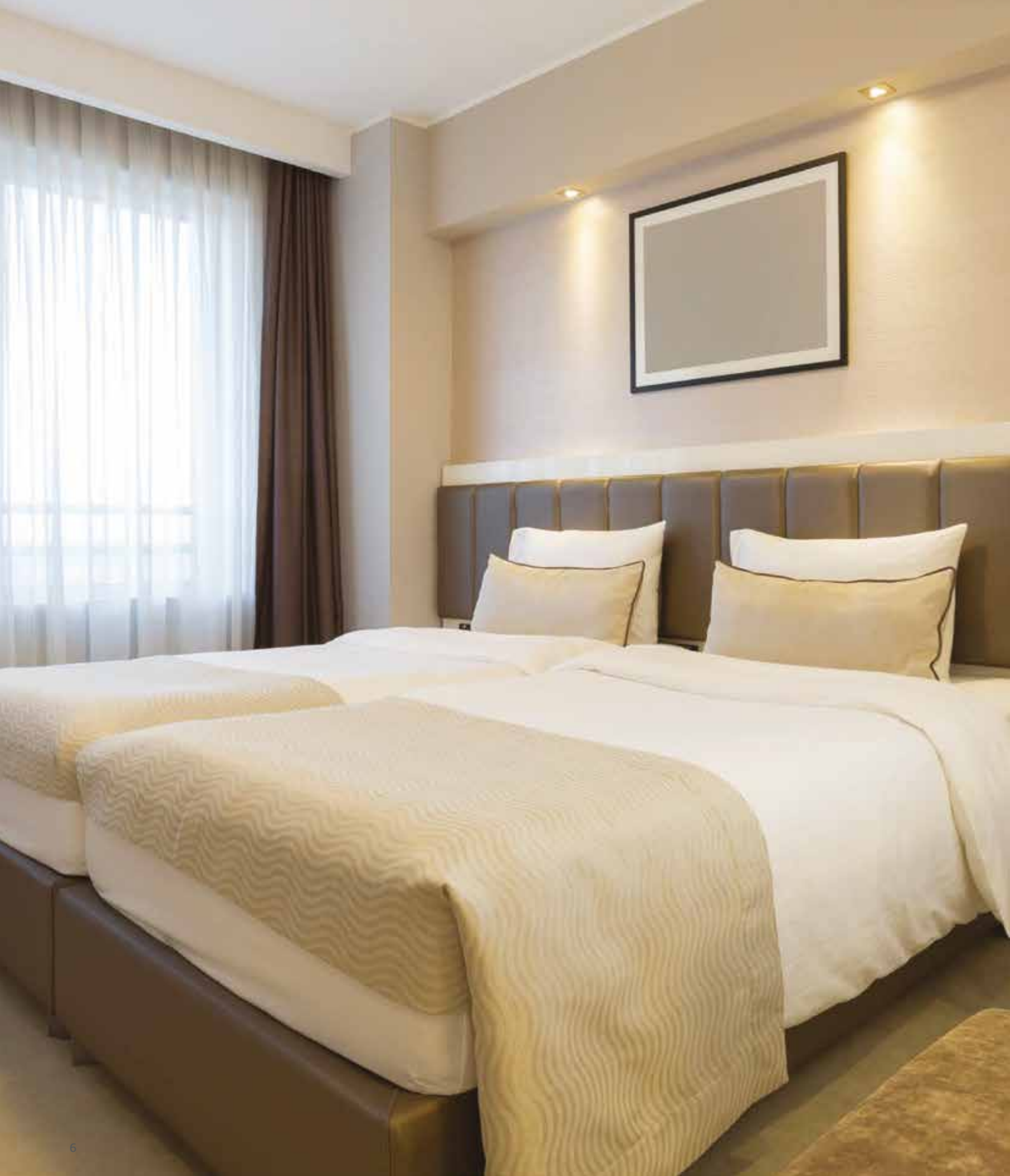

# CEILING CONCEALED DUCT

## E.S.P. (External Static Pressure) Control

This function easily controls volume of the air by a remote controller. The BLDC motor can control fan speed and air volume regardless of the external static pressure. Additional accessories are not required to control air flow.

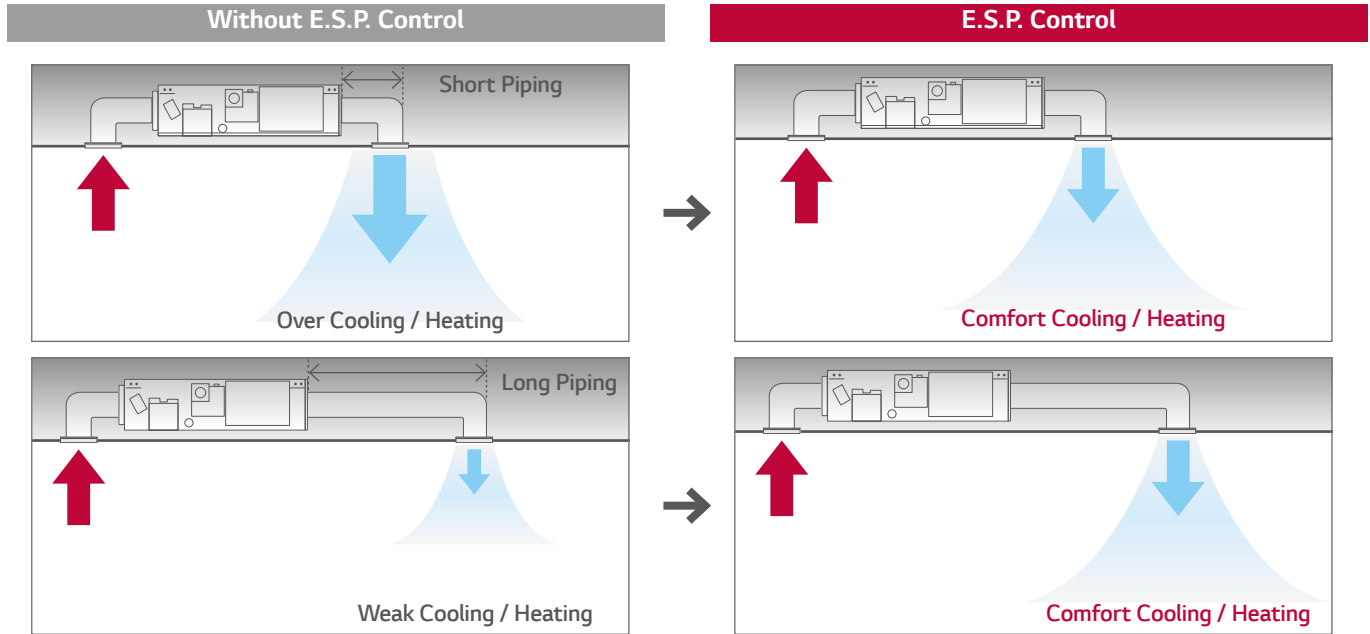

## High Head Drain Pump

High head drain pump automatically drains water up to a height of 200mm of drain-head height. It provides the perfect solution for draining of water. (Standard Inverter : Accessory (ABDPG) / Low-Static Duct : Included)

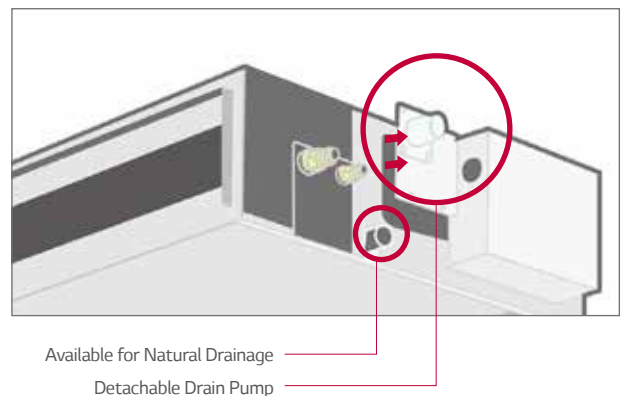
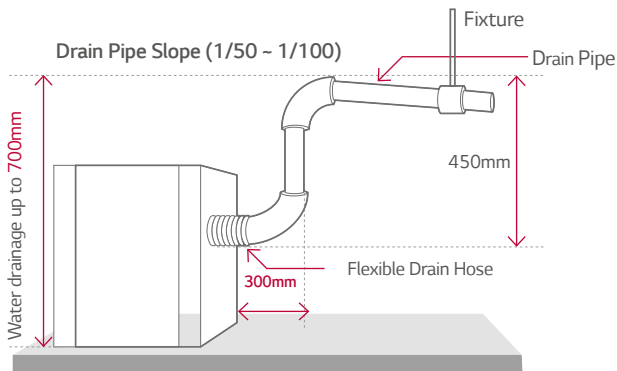

## SINGLE SPLIT KEY FEATURES

# CEILING CONCEALED DUCT

## Two Thermistors Control

The indoor temperature can be checked using the thermistors in the remote controller as well as from the indoor unit. There may be a significant difference between ceiling and floor air temperature. Two thermistors can better optimise indoor air temperature for a more comfortable environment.

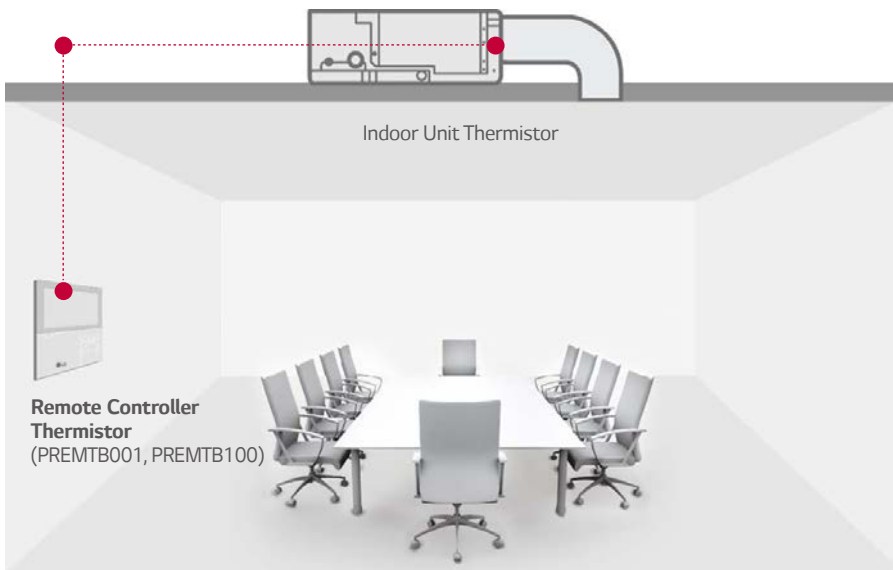

Compares temperatures sensed from different positions, and automatically selects the optimum temperature for users

## Operation for Multiple Rooms

Using a spiral duct (Embedded or flexible type) and stream chamber, it is possible to operate cooling / heating for several rooms simultaneously. Also, zone control is available with zone controller accessory (ABZCA)

### Zone control features

- Controls different zones (up to 4 zones) by external thermostat (AC a24V)
- Maintain proper air volume of each zone
- Auto variation of dampers
- Auto control of fan speed and On / Off operation

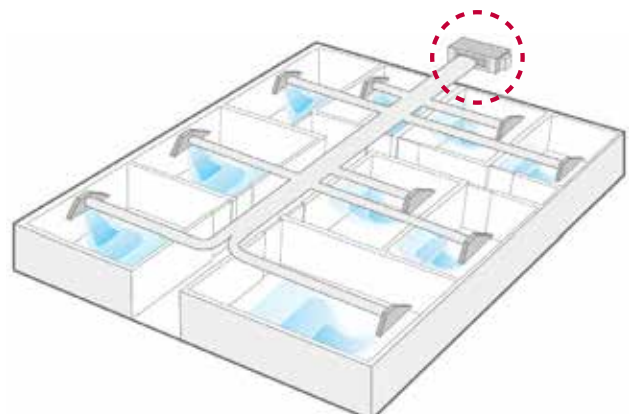
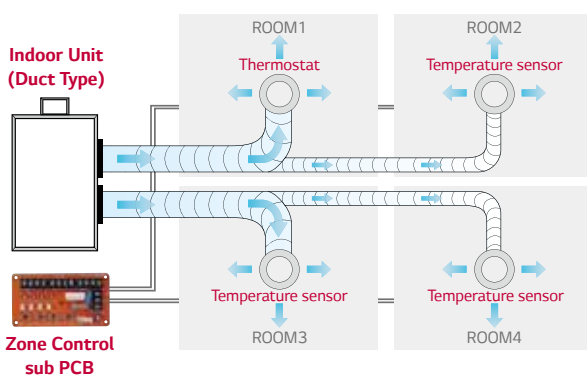



## Minimised Height

New mid-static ducts provide ideal solution for installation in limited space.

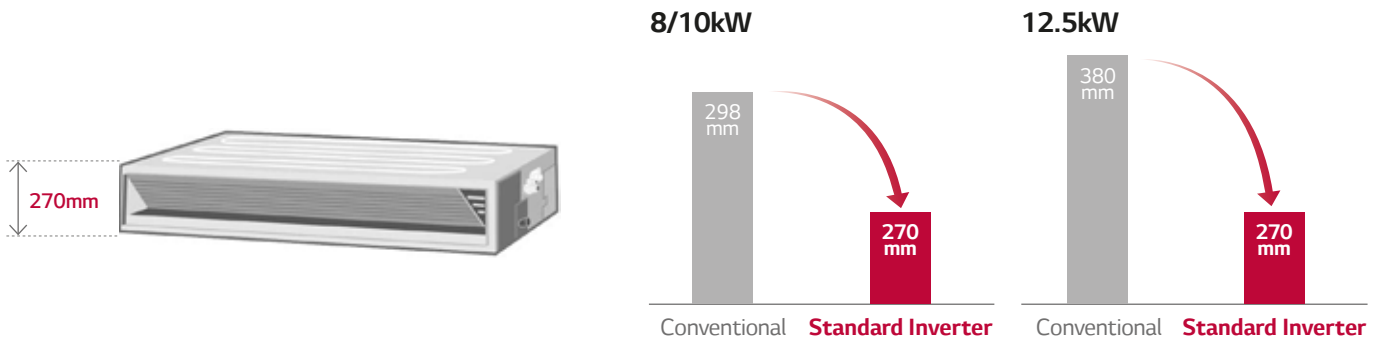

## Wide Operation Range

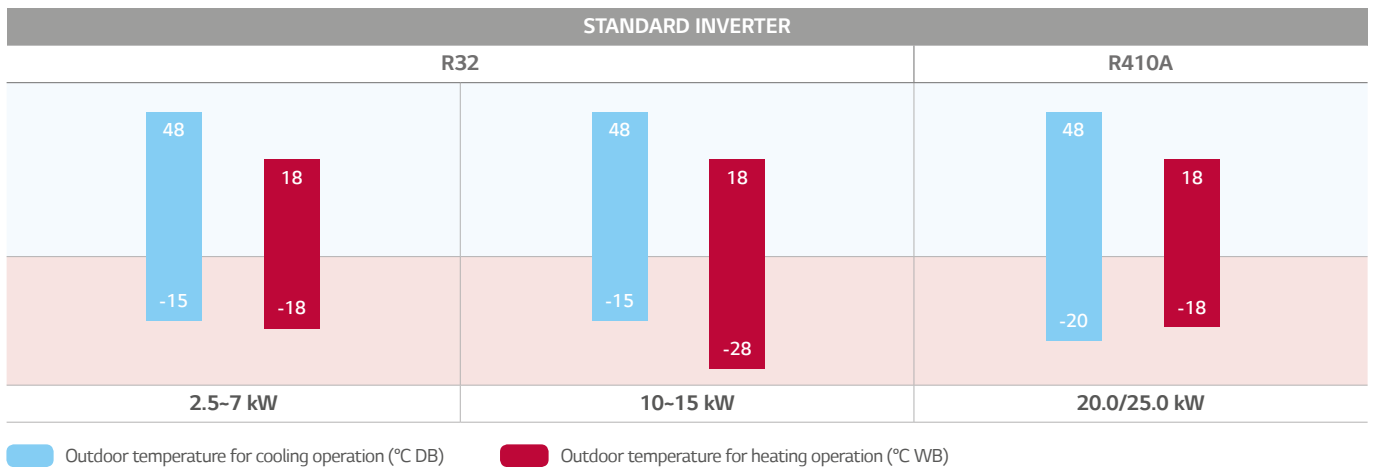

## Easy Service & Maintenance

Users are not required to disassemble the whole panel for maintenance; since panel is divided into 2 components; one for heat exchanger and the other for fan/motor. The user can easily detach and re-attach the filter in the available limited space.

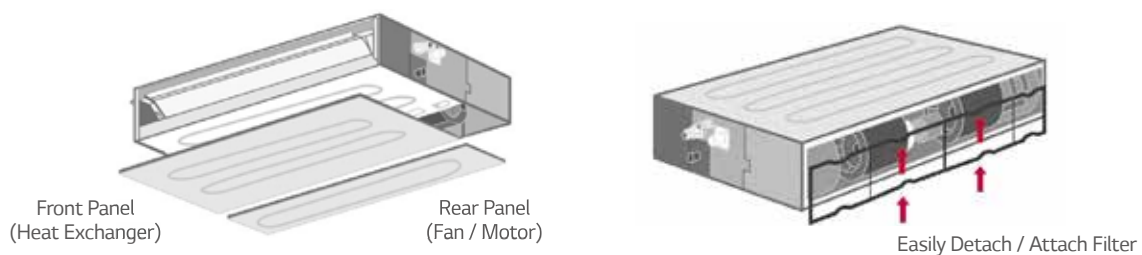

# CEILING CONCEALED DUCT (LOW STATIC PRESSURE)

## Quiet Operation

The noise level of low static ducts have been reduced, even though ESP has been increased.

		CL09R N20	CL12R N20	CL18R N20	CL24R N30
Sound Pressure (High / Medium / Low)	dB (A)	31 / 28 / 27	31 / 28 / 27	36 / 34 / 31	39 / 35 / 32

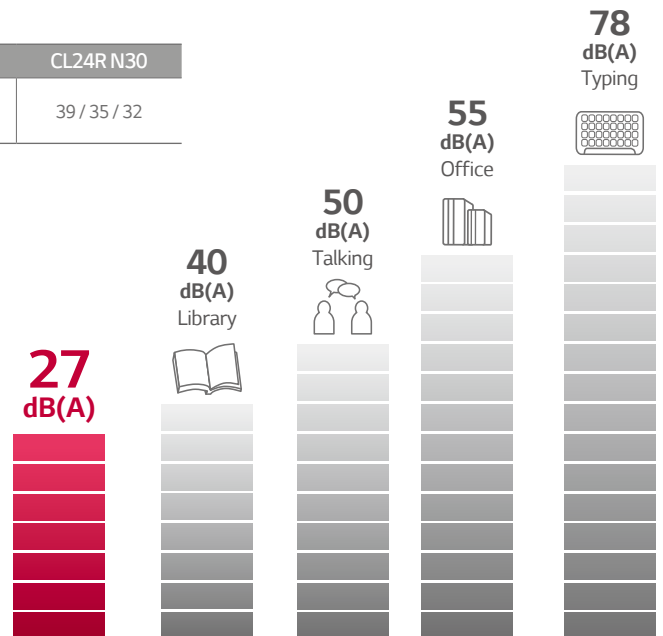

## Flexible Installation

Standard Inverter low static duct allows the air intake at the rear or bottom under installation condition.

### Previous Models

Air intake at the only rear

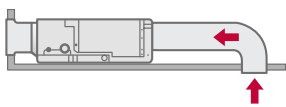

### Standard Inverter Low Static Duct

Air intake at the rear or bottom

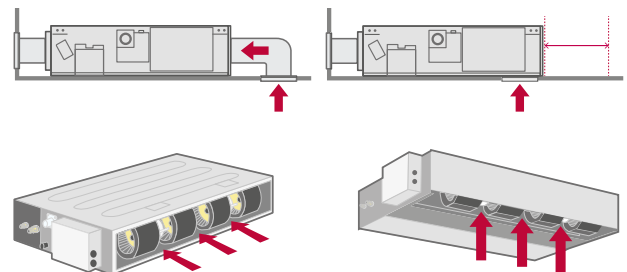

# SINGLE SPLIT SPECIFICATIONS

## CEILING CONCEALED DUCT (R32)

### UBN24R

### UBN36R



Model		Unit		UBN24R	UBN36R
Rated Capacity	Cooling			6.80	9.50
	Heating			7.50	10.80
Capacity Range	Cooling	Min - Max	kW	2.8 - 7.8	4.5 - 13.0
	Heating	Min - Max	kW	3.2 - 8.3	5.0 - 13.7
Rated Power Input	Cooling			2.08	2.43
	Heating			2.21	2.85
AEER / ACOP	Cooling / Heating		-	3.254 / 3.377	3.829 / 3.723
EER / COP	Cooling / Heating		-	3.277 / 3.400	3.909 / 3.789
Rated Current	Cooling / Heating		A	9.00 / 9.80	10.6 / 12.4
Max. Current (Full Load Amps)	Indoor Unit		A	1.6	2.3
	Set		A	17	28
Air Flow Rate			L/s	300 / 275 / 242	533 / 466 / 400
External Static Pressure			Pa	25 - 150	40 - 450
Indoor	Sound Level at 1.5m	H / M / L	Pressure dB(A)	35 / 34 / 32	36 / 34 / 33
	Dimensions	W x H x D	mm	900 x 270 x 700	1,250 x 270 x 700
	Weight		kg	24.2	28.5
Outdoor	Sound Level at 1.5m	Cooling / Heating	Pressure dB(A)	48 / 52	52 / 54
	Sound Power Level		dB(A)	67	66
	Dimensions	W x H x D	mm	950 x 834 x 330	950 x 1,380 x 330
	Weight		kg	56.1	87.5
Power Supply			V / Phase / Hz	220-240, 1, 50	220-240, 1, 50
Circuit Breaker			A	25	40
Compressor Type			-	Twin Rotary	LG Inverter Scroll
Refrigerant	Type			R32	R32
	Precharged Length			7.5	7.5
Pipe Sizes	Liquid			Ø 9.52 (3/8)	Ø 9.52 (3/8)
	Gas			Ø 15.88 (5/8)	Ø 15.88 (5/8)
	Drain OD / ID			Ø 32 / 25	Ø 32 / 25
Max. Pipe Length			m	50	85
Max. Height Difference	ODU ~ IDU		m	30	30
Supply Air Opening	H x W, Flange		mm	200 x 857	200 x 1,206
Return Air Opening	H x W, Flange		mm	231 x 850	230 x 1,205
Continuous Operating Range	Cooling			°C DB	- 15 - 48
	Heating			°C WB	- 18 - 18
Demand Response			-	X	X

Note : 1. Due to our policy of innovation some specifications may be changed without notification.

2. Definition of Power Input Nominal conditions – Performance tested under EN14511

3. Capacities are based on the following conditions:

Cooling : - Indoor Temperature 27°C DB / 19°C WB - Outdoor Temperature 35°C DB / 24°C WB Heating : - Indoor Temperature 20°C DB / 15°C WB - Outdoor Temperature 7°C DB / 6°C WB

4. Annual energy consumption : based on average use of 350 running hours in cooling and 1,400 hours in heating per year at seasonal condition

5. This product contains fluorinated greenhouse gases (R32)

# HIGH STATIC DUCTED

R410A



## KEY FEATURES

# RESIDENTIAL

## Come home to comfort

### Wi-Fi Smart Control Compatible

The LG Smart ThinQ App lets you access and control your air conditioner with your smartphone\* even when you're not at home, so you can come home to comfort. (Optional Wi-Fi dongle module sold separately).



I Controlling & Monitoring I

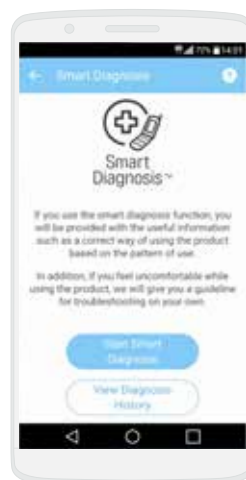

I Smart Diagnosis & Filter Manager I



I Integrated Home Appliances Control I

\*Wi-Fi Dongle Module required. Sold separately. Feature can be accessed using LG SmartThinQ App on Android (v 4.1 or later) iOS (v iOS9 or later) smartphone. Internet connection required.



# RESIDENTIAL

## Zone Control

It is possible to control up to 8 zones from the premium controller and indicate a zone name such as Office, Hallway, etc. There are 18 names to choose from.



Control up to 8 zones with the LG Premium Controller

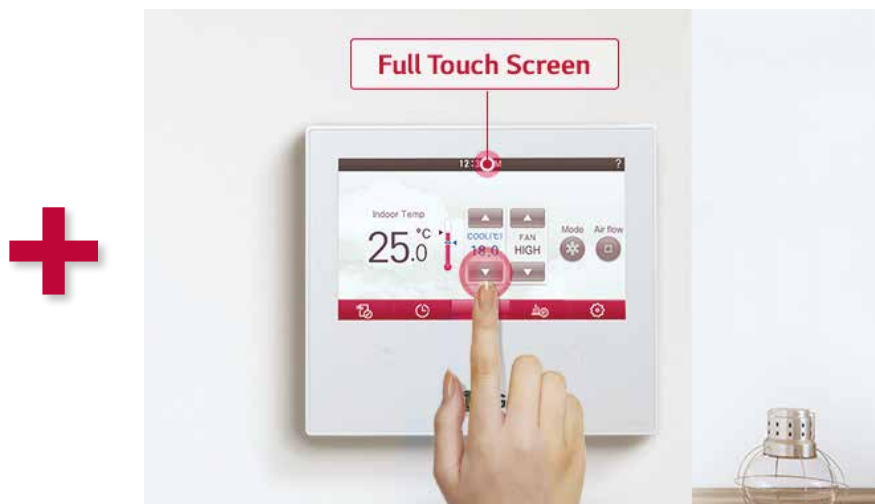

\*Controllers sold separately.

# Variable Airflow Technology (VAT)

Variable Airflow Technology monitors the dampers so that only the required amount of air is discharged into the space. This helps to lower energy consumption by up to 20%\*.



\*LG internal test result based on previous 15kW Duct model B55AWYN7G5 vs. new 15kW Duct model B55AWYN7G6.

## Premium Controller

### Touch Colour Screen Controller\*

The LG Individual controller provides intuitive GUI with colour LCD and touch type interface Main Screen Selection - Choose between detailed and simple formats to meet your Schedule Control needs - Allows temperature control in conjunction with the time of day, allowing a customised setting that suits your lifestyle.

#### Premium Controller



Touch Screen



Main Display



Zone Control



Weekly Schedule

\*Sold separately.

KEY FEATURES

# CONTROLLERS

## Premium Design with Intuitive Interface

The luxurious design of the premium controller complements the interior design through a colourful display coupled with a simple user friendly button layout, making it easier to control.

## Energy Monitoring

The Premium Controller provides additional visibility on energy usage

Standard Controller

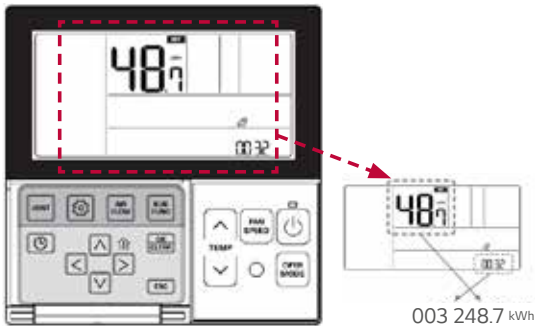

Total accumulated power consumption only.

Premium Controller



Weekly / Monthly / Yearly (kWh & hr)



Year on year usage

## Zone Control

The Premium Controller provides control over more zones (eight) and allows zones to be renamed.

Premium Controller



On/Off only



Zone naming is available.

- Pre-set : Zone, Office, Hallway, Lobby, Room, Living, Kitchen, Etc



# Filter Clean Information

The Premium Controller provides additional information on how long you have until you need to clean your filter.

Standard Controller

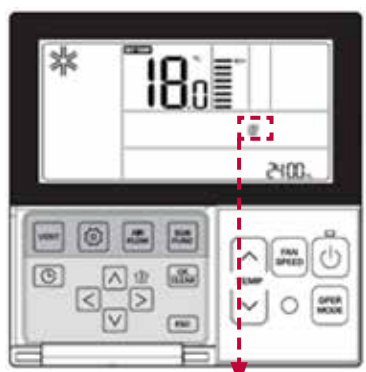

filter cleaning indication

Only display

Premium Controller

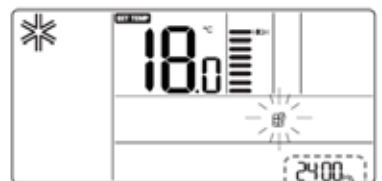

# Child Lock Function

The Premium Controller provides additional child lock options.

Standard Controller

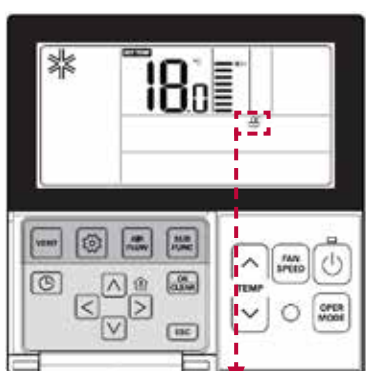

Child Lock (All Lock) only

Premium Controller



- All Lock  
It locks all button operation
- On/Off Lock  
It locks the On/Off button
- Mode Lock  
It locks the operation mode button
- Temperature Range Lock  
It is the function that can limit the range of the desired temperature  
Lower limit: 16°C-30°C  
Upper limit: 18°C-30°C

# CONTROLLERS

## 2 Set-Point Auto (Home Leave - Premium Controller Only)

The Premium Controller "Home Leave" function sets the room temperature to stay between a range of two set temperature points when your home is unoccupied. This allows for a quicker return to a comfortable indoor environment when you return.

Premium Controller

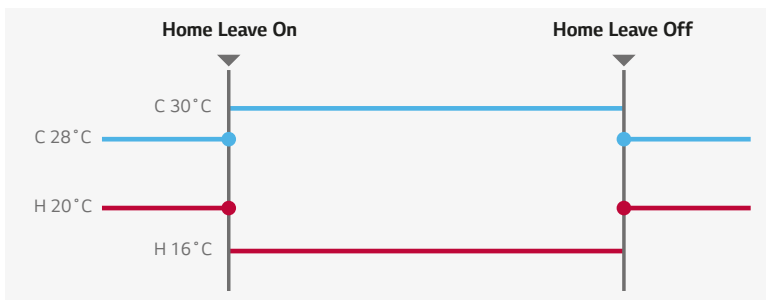

## Summer Hours Setting (Premium Controller Only)

Summer time: The premium controller allows you to advance the time by 1 hour from the spring and return back in Autumn when the day gets shorter.

Premium Controller



Ex) When it becomes AM 02:00 on the AEDST start date, the current time changes to AM 03:00, and when it becomes AM 02:00 of the AEDST end date, the current time changes to AM 01:00.

## KEY FEATURES SUMMARY

# CONTROLLERS



Category		Standard	Premium
		PREMTB001	PREMTA000
Size (mm, W x H x D)		121 x 120 x 15	137 x 121 x 16.5
Basic Control	On/Off, Fan Speed	•	•
	Desired Temperature	•	•
	Operation Mode	•	•
Reservation	Simple On/Off	•	•
	Sleep	•	•
	ON Time	•	•
	OFF Time	•	•
	Weekly	•	•
	Yearly		•
	Holiday	•	•
Energy Monitor			•
Time Limit Control			•
Child Lock / All Lock		•	•
Time Display		•	•
Electric Failure Compensation		• (3 hours)	• (50 hours)
Wireless R/C IR Receiver		•	•

# RESIDENTIAL

## Energy Efficiency

### Efficiency Comparison

The energy efficiency increase vs previous LG models (10.5kw), helps to lower operating costs. (Cooling AEER 14%↑ and Heating ACOP 24%↑)

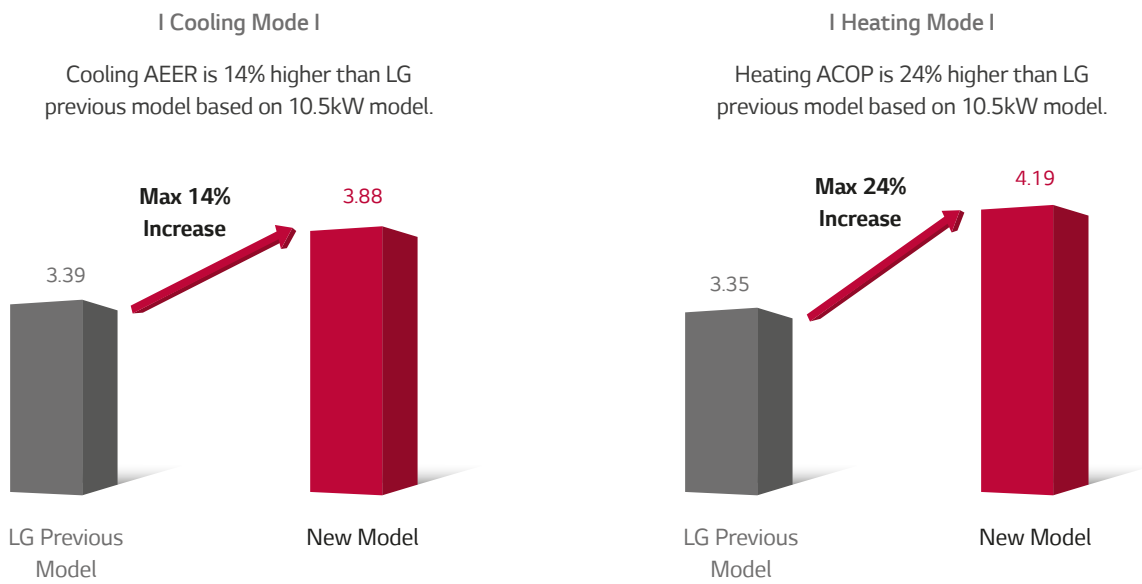

## LG Quick Cooling

Pressure control is more efficient\* so it takes less time to reach your desired temperature.

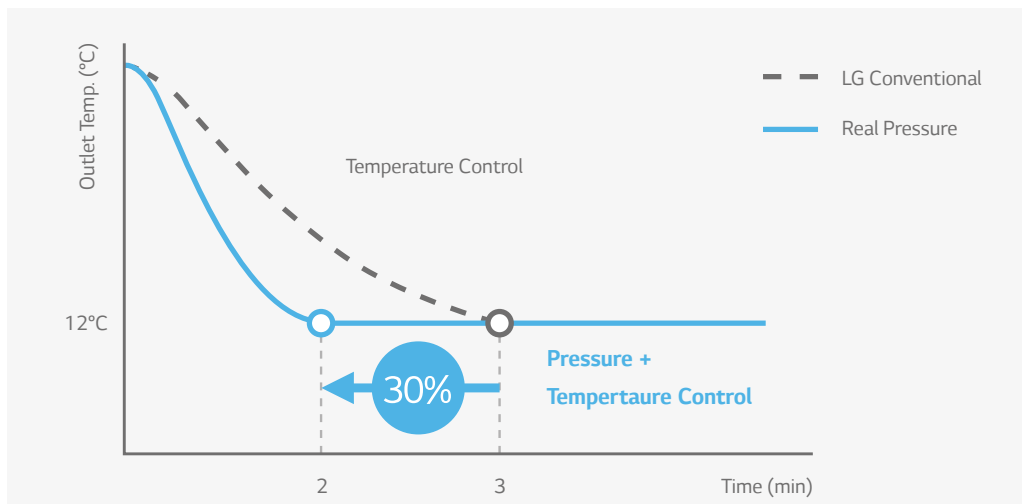

\* vs. LG Conventional.

# Cooling Season - Operation Cost Reduction

The latest Inverter technology from LG helps to lower cooling costs in the summer.

I LG Previous Model vs. LG New Inverter I

Operation cost (\$ / Cooling Season)

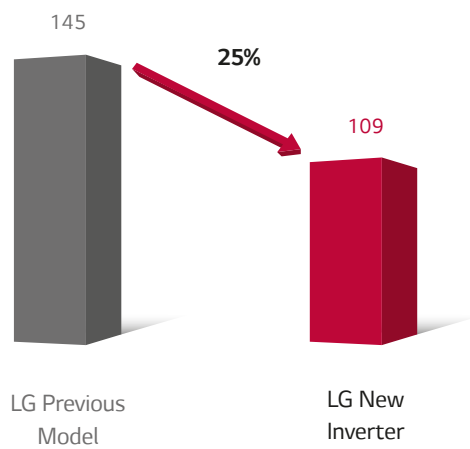

※ **Cooling Season energy simulation condition:**

- 1) Model : Inverter B42AWYN7G5A / B42AWYU3G5A, Inverter B42AWYN7G6 / B42AWYU3G6
- 2) Location : Australia, Sydney
- 3) Cooling load : 12.5 kW
- 4) Operation time : 12pm – 9pm / Nov. – Feb.
- 5) Setting Temperature : AEER 3.80
- 6) Electric rate : 0.25 AUS\$/kWh (for Residential)
- 7) Simulated by LG Energy Estimate Program



# RESIDENTIAL

## Unoccupied Mode

When you leave your home unoccupied, instead of turning your system off and letting your home get hot or cold, you can press the dedicated unoccupied button which will set the room temperature to stay between a range of two set temperature points. This allows for a quicker return to a comfortable indoor environment when you return.

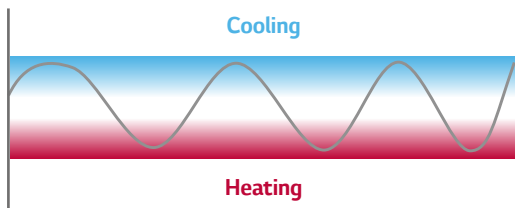

Just setting one time, keeping comfortable at all times

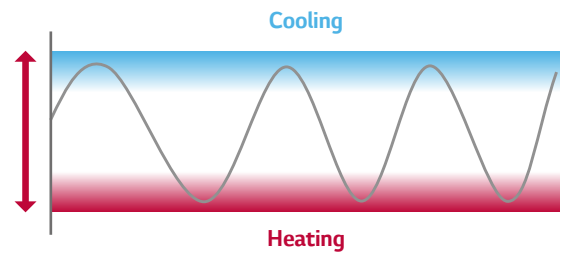

In occupied schedule mode, the set range is narrow to keep the indoor environment optimised as per temperature preference.

When you go out, instead of turning off your air conditioning, you can use unoccupied schedule mode. The set range is wide which allows the indoor environment to be restored to your preference quicker, than if you turned off your air conditioning.

\* Home Leave Set Temperature function can only be used in a 2 set control mode.

# Quiet Mode

Night Silent Operation can reduce noise levels at night time by setting the dip switch on the PCB of the outdoor unit\*.

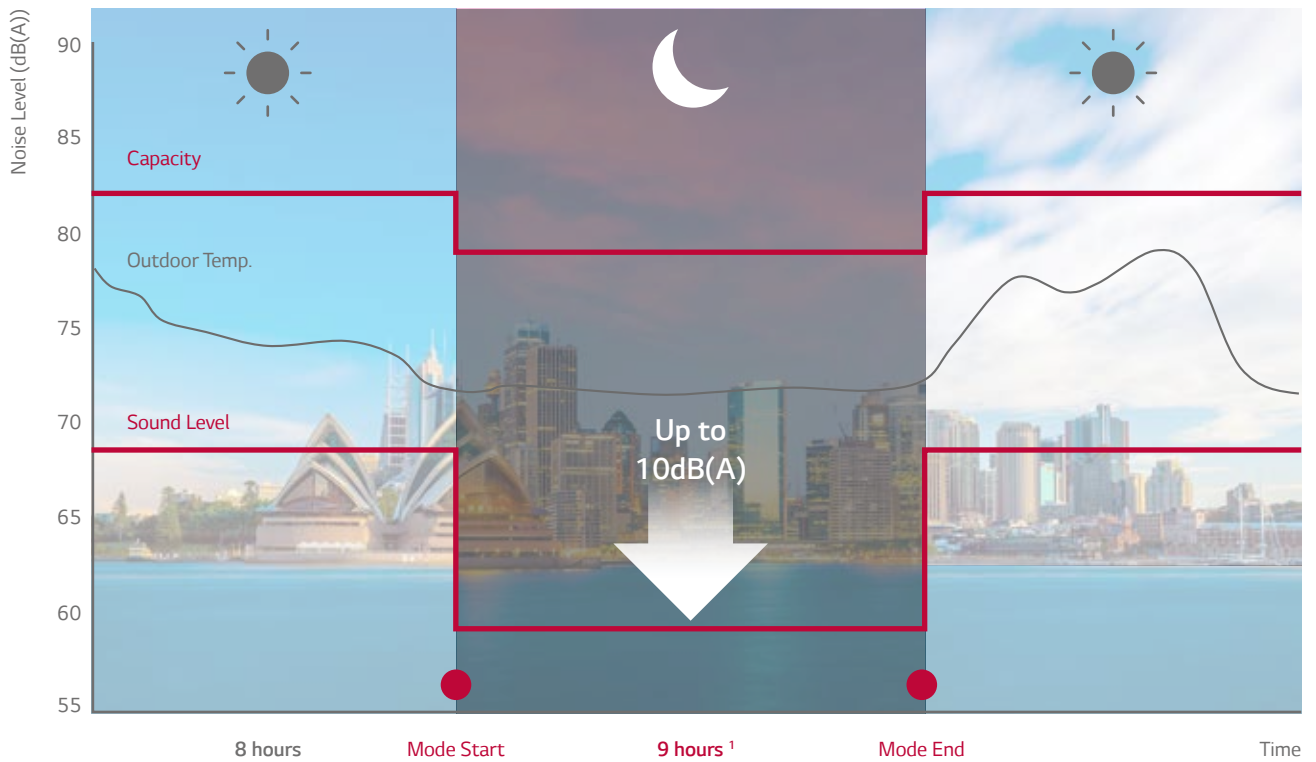

\*Based on cooling operation

- ✘ When the technician sets to low noise operation, the cooling capacity may be decreased.
- ✘ The value of noise level is based on 15kW model.

## KEY FEATURES

# RESIDENTIAL

## External Controller Management\*

Programmable thermostats have become popular due to their energy saving benefits, improved comfort and convenience.



\* LG dry contact sold separately. Please check with your dealer to ensure compatibility between your 3rd party thermostat and the LG Air Conditioner

## Home Automation System\*

A home automation system can control lighting, climate, entertainment systems and appliances.



\* LG Modbus RTU gateway sold separately.



## Compact Indoor Unit

The premium ducted split system has a small chassis. This small split type of indoor unit helps make it easy to install in narrow and small spaces\*.

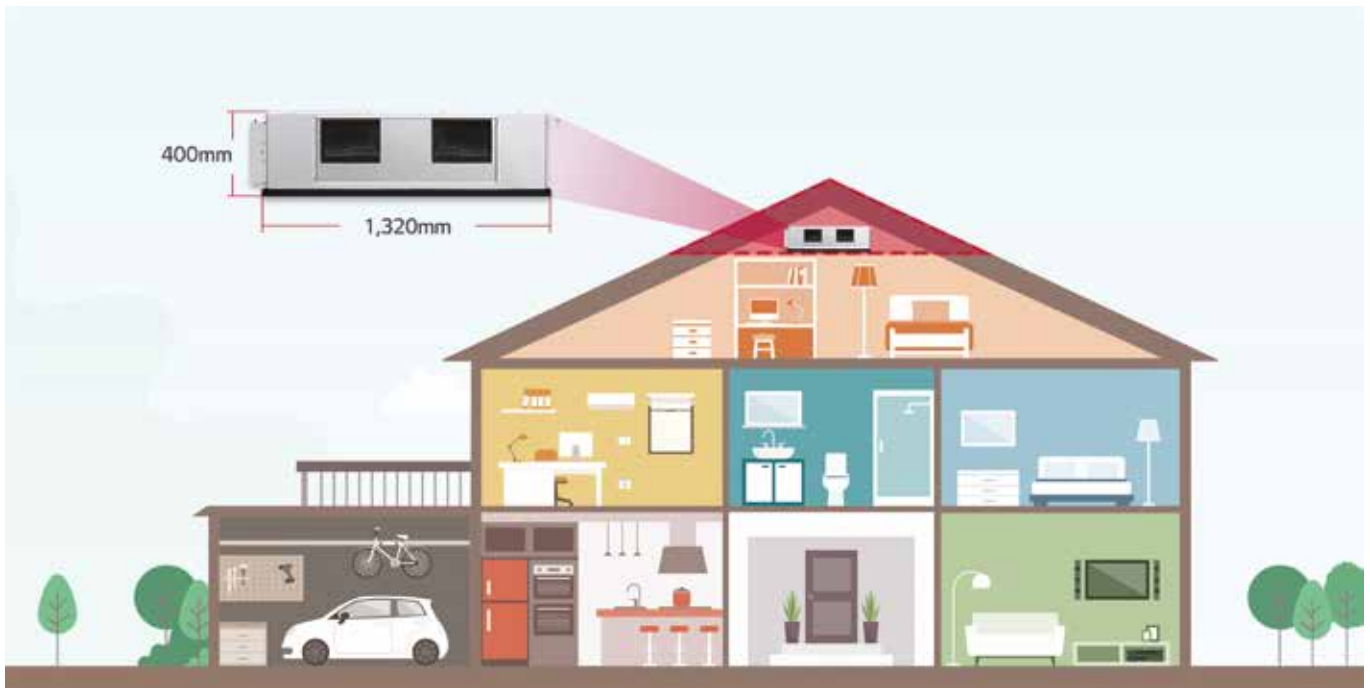

\* Image not to scale. For illustrative purposes only. Consult air conditioning installer for installation options.

## Double Drain Pan

To prevent damage caused by accidental leakage or blocked drain, the indoor unit has an integrated safety tray.

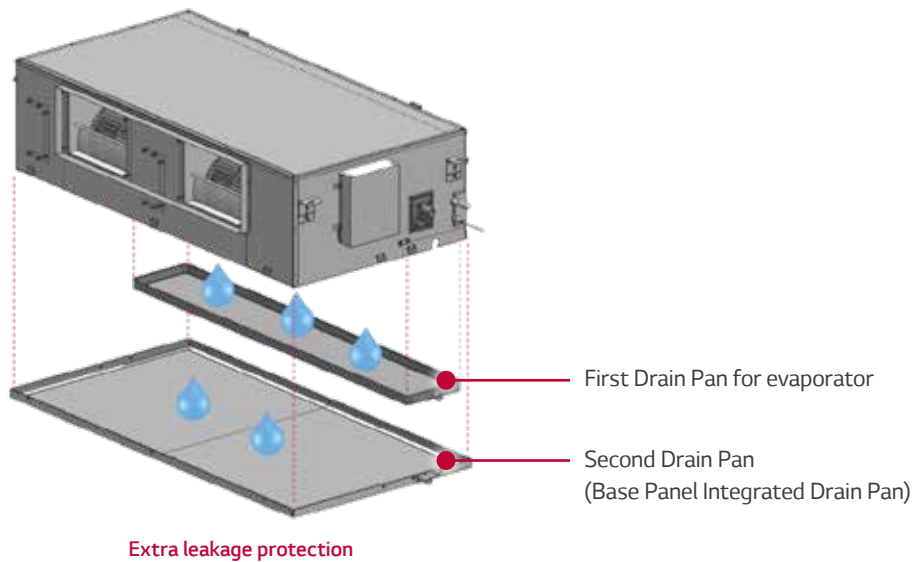

## KEY FEATURES

# RESIDENTIAL

## Smart Diagnosis\*

Monitor the status of your air conditioner and diagnose problems by connecting it to a smartphone via a SIMs chip\*.



\*SIMs Module optional (technician only option).

SIM app:

1. Use a SIM's chip to connect a smartphone to an air-conditioner.
2. Monitor & diagnose in real time using the SIM app.

## Detection of Refrigerant Change

The refrigerant levels are continuously monitored. If the amount of refrigerant drops to 60%, an alert will be sounded and running will be stopped.



# Peak Current Control

Through the peak current control technology, it is possible to save energy and operational costs.

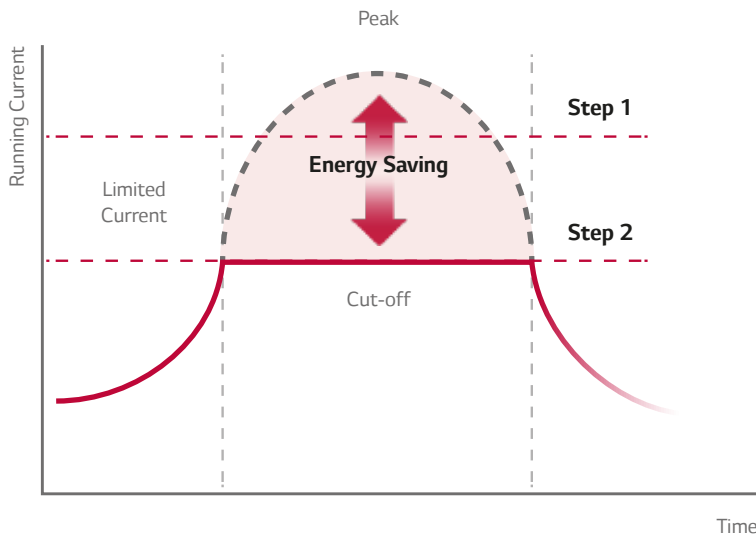

By limiting to the maximum running current, the air conditioner can avoid running on the peak current level.

This function can reduce energy cost during peak periods when electric charge is expensive.

### I How to set dip switch I

● Full Load Consumption : 4.6 kW

● Max. power Consumption : 3.6 kW

**22% reduction**

Step 1



● Max. power Consumption : 3.1 kW

**33% reduction**

Step 2



• Based on 15 kW model  
• LG Internal test result

# GoldFin™

The gold-coloured special coating on the fin of the heat exchanger prevents corrosion, extending the life of the unit.

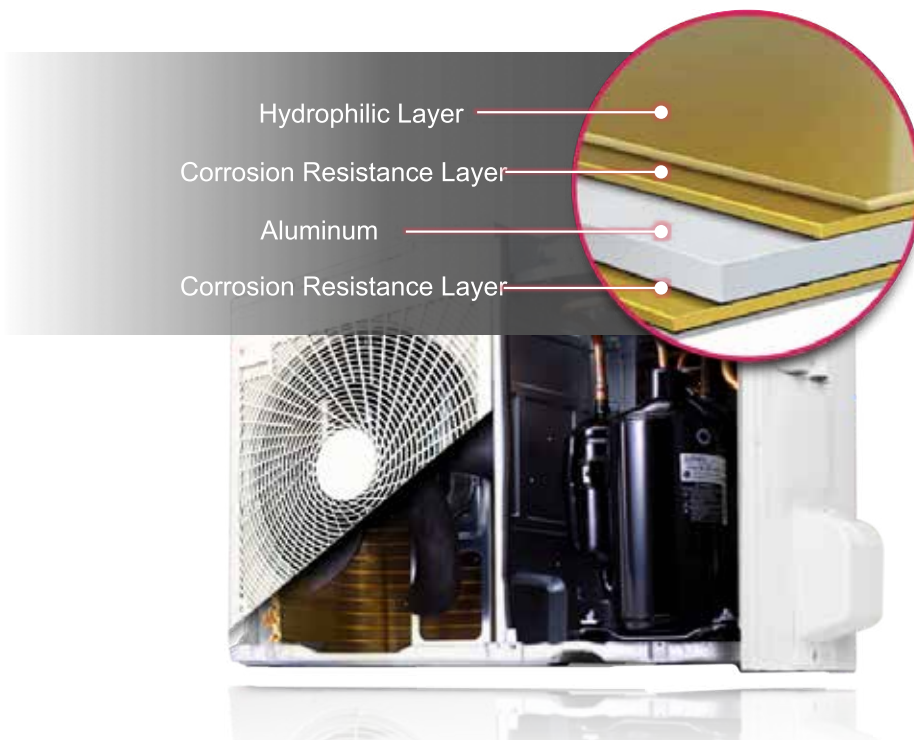

# SPECIFICATIONS

## PREMIUM RANGE

**B30AWY7G6**

**B42AWY7G6**

**B36AWY7G6**

**B55AWY7G6**



Model		Unit	B30AWY7G6	B36AWY7G6	B42AWY7G6	B55AWY7G6	
Rated Capacity	Cooling	kW	8.8	10.5	12.5	15	
	Heating	kW	9.4	13	15	17	
Capacity Range	Cooling	Min ~ Max	kW	2.5 ~ 9.6	3.2 ~ 13	4.0 ~ 14.8	4.8 ~ 15.8
	Heating	Min ~ Max	kW	2.7 ~ 11.1	3.4 ~ 13.7	4.0 ~ 16.5	4.8 ~ 18.0
Rated Power Input	Cooling	kW	2.58	2.75	3.35	4.6	
	Heating	kW	2.32	3.1	3.8	4.68	
AEER / ACOP	Cooling / Heating	-	3.39 / 4.0	3.79 / 4.1	3.71 / 3.93	3.25 / 3.62	
EER / COP	Cooling / Heating	-	3.41 / 4.05	3.82 / 4.19	3.73 / 3.95	3.26 / 3.63	
Rated Current	Cooling / Heating	A	11.4 / 10.3	12.2 / 13.8	14.9 / 16.9	20.4 / 20.8	
Max. Current (Full Load Amps)		A	17	29	29	29	
Rated Air Flow Rate		L/s	533 / 433 / 333	700 / 600 / 467	833 / 717 / 600	1000 / 833 / 667	
Indoor	Sound Level at 1.5m	H / M / L	Pressure dB(A)	41 / 40 / 39	43 / 41 / 40	44 / 42 / 41	45 / 44 / 42
	Dimensions	W x H x D	mm	1,320 x 400 x 534	1,320 x 400 x 534	1,320 x 400 x 534	1,320 x 400 x 534
	Weight		kg	48	48	52	52
Outdoor	Sound Level at 1m	Cooling / Heating	Pressure dB(A)	51 / 52	53 / 54	53 / 54	54 / 56
	Sound Power Level		dB(A)	64	65	66	68
	Dimensions	W x H x D	mm	950 x 834 x 330	950 x 1,380 x 330	950 x 1,380 x 330	950 x 1,380 x 330
	Weight		kg	58.5	87.5	87.5	87.5
Power Supply		V / Phase / Hz	220-240, 1, 50	220-240, 1, 50	220-240, 1, 50	220-240, 1, 50	
Circuit Breaker		A	25	40	40	40	
Compressor Type		-	Inverter Twin Rotary	Inverter Scroll	Inverter Scroll	Inverter Scroll	
Refrigerant	Type	-	R410A	R410A	R410A	R410A	
	Precharged Length	m	10	20	20	20	
Pipe Sizes	Liquid	mm/inch	Ø 9.52 (3/8)	Ø 9.52 (3/8)	Ø 9.52 (3/8)	Ø 9.52 (3/8)	
	Gas	mm/inch	Ø 15.88 (5/8)	Ø 15.88 (5/8)	Ø 15.88 (5/8)	Ø 15.88 (5/8)	
	Drain OD / ID	mm	Ø 32 / 25	Ø 32 / 25	Ø 32 / 25	Ø 32 / 25	
Max. Piping Length		m	30	75	75	75	
Max. Height Difference	ODU - IDU	m	30	30	30	30	
Supply Air Opening	H x W, Flange	mm	287 x 840	287 x 840	287 x 840	287 x 840	
Return Air Opening	Oval	mm	317 x 1,172	317 x 1,172	317 x 1,172	317 x 1,172	
Continuous Operating Range	Cooling	°C DB	-15 ~ 48	-15 ~ 48	-15 ~ 48	-15 ~ 48	
	Heating	°C WB	-18 ~ 18	-18 ~ 18	-18 ~ 18	-18 ~ 18	
Demand Response		-	Capable	Capable	Capable	Capable	

Note : 1. Due to our policy of innovation some specifications may be changed without notification.

2. Capacities are in accordance with AS/NZS3823.1.2

Cooling - Indoor Temperature 27°C DB / 19°C WB

- Outdoor Temperature 35°C DB / 24°C WB

Heating - Indoor Temperature 20°C DB / 15°C WB

- Outdoor Temperature 7°C DB / 6°C WB

# SPECIFICATIONS

## STANDARD RANGE

### B62AWYN9L6

### B70AWYN9L6



Model		Unit	B62AWY9L6	B70AWY9L6
Rated Capacity	Cooling	kW	18.0	20.0
	Heating	kW	20.6	22.6
Capacity Range	Cooling	Min - Max	7.2 - 19.8	8.0 - 22.0
	Heating	Min - Max	8.2 - 22.7	9.0 - 24.9
Rated Power Input	Cooling	kW	5.47	6.47
	Heating	kW	5.49	6.19
EER / COP	Cooling / Heating	-	3.29 / 3.75	3.09 / 3.65
Rated Current	Cooling / Heating	A	9.3 / 9.6	10.9 / 10.5
Rated Air Flow Rate		L/s	1,333 / 1,200 / 1,067	1,333 / 1,200 / 1,067
Indoor	Sound Level at 1.5m	H / M / L	Pressure dB(A)	43 / 41 / 40
	Dimensions	W x H x D	mm	1,563 x 458 x 791
	Weight		kg	89
Outdoor	Sound Level at 1m	Cooling / Heating	Pressure dB(A)	59 / 60
	Sound Power Level		dB(A)	71
	Dimensions	W x H x D	mm	1,090 x 1,625 x 380
	Weight		kg	144
Rated Power Input	Indoor	V / Phase / Hz	220-240, 1, 50	220-240, 1, 50
	Outdoor		380-415, 3, 50	380-415, 3, 50
Circuit Breaker		A	30	30
Compressor Type		-	Hermetically Sealed Scroll	Hermetically Sealed Scroll
Refrigerant	Type	-	R410A	R410A
	Precharged Length	m	15	15
Pipe Sizes	Liquid	mm/inch	Ø 12.7 (1/2)	Ø 12.7 (1/2)
	Gas	mm/inch	Ø 22.8 (7/8)	Ø 22.8 (7/8)
	Drain OD / ID	mm	Ø 32 / 25	Ø 32 / 25
Max. Piping Length		m	75	75
Max. Height Difference	ODU - IDU	m	30	30
Supply Air Opening	H x W, Flange	mm	286 x 1,044	286 x 1,044
Return Air Opening	Oval	mm	392 x 1,368	392 x 1,368
Continuous Operating Range	Cooling	°C DB	-20 - 48	-20 - 48
	Heating	°C WB	-18 - 18	-18 - 18

Note : 1. Due to our policy of innovation some specifications may be changed without notification.

2. Capacities are in accordance with AS/NZS3823.1.2

Cooling: - Indoor Temperature 27°C DB / 19°C WB





- Outdoor Temperature 35°C DB / 24°C WB

Heating: - Indoor Temperature 20°C DB / 15°C WB

- Outdoor Temperature 7°C DB / 6°C WB

# ACCESSORIES

## INTERFACE DEVICE

Control Method	Objective/Use	Unit Name and Model	Function	Parts	Features
PI485 PMNFP14A1	To connect Outdoor unit to CNU or Simple Central Controller		<ul style="list-style-type: none"> <li>• RS485 Converter with software</li> <li>• For Max.16 Indoor</li> </ul>	<ul style="list-style-type: none"> <li>• PCB Assembly</li> <li>• Bracket</li> <li>• Lead wire: 3ea</li> <li>• Screw 4EA</li> <li>• Tie wrap</li> <li>• Clamp</li> <li>• Manual</li> </ul>	<ul style="list-style-type: none"> <li>• 1set/1 Outdoor</li> </ul>
Dry Contact PDRYCB100	For connect Indoor unit to other Forced on/off Controller	 	<ul style="list-style-type: none"> <li>• RS485 Converter with software</li> </ul>	<ul style="list-style-type: none"> <li>• PCB Assembly</li> <li>• Top case</li> <li>• Bottom case</li> <li>• Screw</li> <li>• Lead wire 3</li> <li>• Sub PCB set (1 leadwire + 1 sub PCB)</li> <li>• Manual</li> </ul>	<ul style="list-style-type: none"> <li>• 1set/1 Indoor unit</li> </ul>
Dry Contact PDRYCB400	For connect Indoor unit to other Forced on/off Controller	 	<ul style="list-style-type: none"> <li>• Contact signal to air-con signal converter</li> </ul>	<ul style="list-style-type: none"> <li>• PCB Assembly</li> <li>• Top/Bottom case</li> <li>• Screw</li> <li>• Lead wire 3ea</li> <li>• Sub PCB set (1 leadwire + 1 sub PCB)</li> <li>• Manual</li> </ul>	<ul style="list-style-type: none"> <li>• 1set/1 indoor unit</li> <li>• 2 Contact points</li> <li>• No need AC input</li> <li>• Expected temperature setting is possible</li> </ul>

\*Dred/Dry contact.

## PREMIUM DUCTED SYSTEM ACCESSORIES\*

Model	Description
PREMTB001	Standard Wired Wall Controller
PREMTA000	Premium Controller
PBZC80	Damper Controller 8 Zone
PQWRHQ0FDB	Wireless Remote Control
ABDPG	Mid Static Drain Pump
ABDP7	Drain Pump Kit (8.8kW - 15kW)
PBDP9	Drain Pump Kit (18kW - 20kW)
PWFMDD200	WiFi Dongle + 1.1m Cable
PWYREW000	10m Cable
ABZCA	Damper 4 Zone Controller

\*Refer to each model PDB for application accessories.

# ACCESSORIES

## BUILDING MANAGEMENT DEVICES

Control Method	Objective/Use	Unit Name and Model	Function	Parts	Features
BNU-LW PLNWKB000	To connect PI485 to LONWORKS BMS system		<ul style="list-style-type: none"> <li>Interface between BMS and LG air-conditioners (LonMark certified : Operation system based on LNS)</li> </ul>	<ul style="list-style-type: none"> <li>Interface Assembly</li> <li>12V DC adaptor</li> <li>Manual</li> </ul>	<ul style="list-style-type: none"> <li>64 indoor units</li> <li>ACP function (central controller) included</li> </ul>
BNU-BAC PQNFB17C 0	To connect PI485 to BACnet BMS system		<ul style="list-style-type: none"> <li>Interface between BMS and LG air-conditioners (BTL certified : Operation system based on BACnet service)</li> </ul>	<ul style="list-style-type: none"> <li>Interface Assembly</li> <li>12V DC adaptor</li> <li>Manual</li> </ul>	<ul style="list-style-type: none"> <li>256 Indoor units</li> <li>ACP function (central controller) included</li> <li>BTL certification (B-ASC)</li> </ul>
PDI STANDARD PPWRDB000	To Power consumption Distribution of each indoor unit 2-port		<ul style="list-style-type: none"> <li>Accumulation of total power consumption</li> <li>Indication of current power in use</li> <li>Indication of accumulated power for period</li> <li>Indication of standby power (option setting)</li> </ul>	<ul style="list-style-type: none"> <li>PDI Assembly Manual</li> </ul>	<ul style="list-style-type: none"> <li>1 PDI / 2 Outdoor</li> </ul>
PDI Premium PQNUD1S40	To power consumption distribution of each indoor unit 8-port		<ul style="list-style-type: none"> <li>Accumulation of total power consumption</li> <li>Indication of current power in use</li> <li>Indication of accumulated power for period</li> <li>Indication of standby power</li> <li>Blackout protection</li> </ul>	<ul style="list-style-type: none"> <li>PDI Assembly manual</li> </ul>	<ul style="list-style-type: none"> <li>1 PDI / 8 Outdoor</li> </ul>

1) PI485 : Product Interface unit for RS 485 transmission



For more information visit  
[lg.com/au/ducted-air-conditioning](http://lg.com/au/ducted-air-conditioning)